

atlasPLAN



COLOURS BOOK

2025

Atlas Plan is the Atlas Concorde brand
that specialises in the creation
of large-size ceramic slabs.



DOWNLOAD
CATALOG

atlasPLAN

COLORS BOOK

2025

atlas concorde

A system of indoor and outdoor surfaces: floors, walls and decors.

- Floor
- Wall
- Decors
- Outdoor
- Facades

atlasPLAN

Large slabs for kitchen countertops, tables and for furnishings.

- Slabs for countertops and furniture

atlas concorde habitat

Furniture in combination with Atlas Concorde surfaces.

- Bathroom furniture
- Tables

Three brands, **one space.**

- Furniture
- Countertops
- Sinks
- Facades
- Wall
- Floor

New colors

MARBLE LOOK

Ice Crystal	14
Sky Stone	18
Taj Mahal	20
Baobab	24
Black Tempest	28

STONE LOOK

Boost Icor Bone	30
Boost Icor Dune	34

CONCRETE LOOK

Boost Natural Kaolin	38
----------------------	----

MARBLE LOOK

Appennino	42
Silver Root	44
Calacatta Gold NV*	46
Calacatta Meraviglia	48
Calacatta Bernini NV*	52
Calacatta Apuano	54
Calacatta Extra NV*	58
Calacatta Antique	64
Calacatta Imperiale NV*	66
Calacatta Delicato	69
Calacatta Prestigio	70
Crystal White	74
Onyx White	76
White Cloud	78
Bianco Dolomite	79
Statuario Supremo NV*	80
Travertino White	84
Travertino Pearl	86
Travertino Sand	87
Cream Prestige	88
Desert Soul	90
Exotic Wave	92
Exotic Green	94
Fior Di Bosco	96
Light Grey Stone	98
Grey Stone	99
Precious Brown	100
Nero Marquina	102
Black Atlantis	104

STONE LOOK

Boost Stone Ivory	106
Boost Mineral Grey NB*	107
Kone Mix NB*	108
Basaltina Volcano NB*	109
Negresco	110
Soapstone Dark NB*	112
WOOD LOOK	
Noce Canaletto NB*	113

CONCRETE LOOK

Boost White	114
Boost Balance Ash	118
Boost Natural Pro Sand	122
Boost Natural Ecrú	123
Boost Grey	124
Boost Smoke	128
Boost Tarmac	132

SOLID LOOK

Absolute White	136
Absolute Black	137
Black Lava	138

METAL LOOK

Blaze Iron	139
------------	-----



Large sizes for any application

Furniture Countertops Sinks Facades Wall Floor

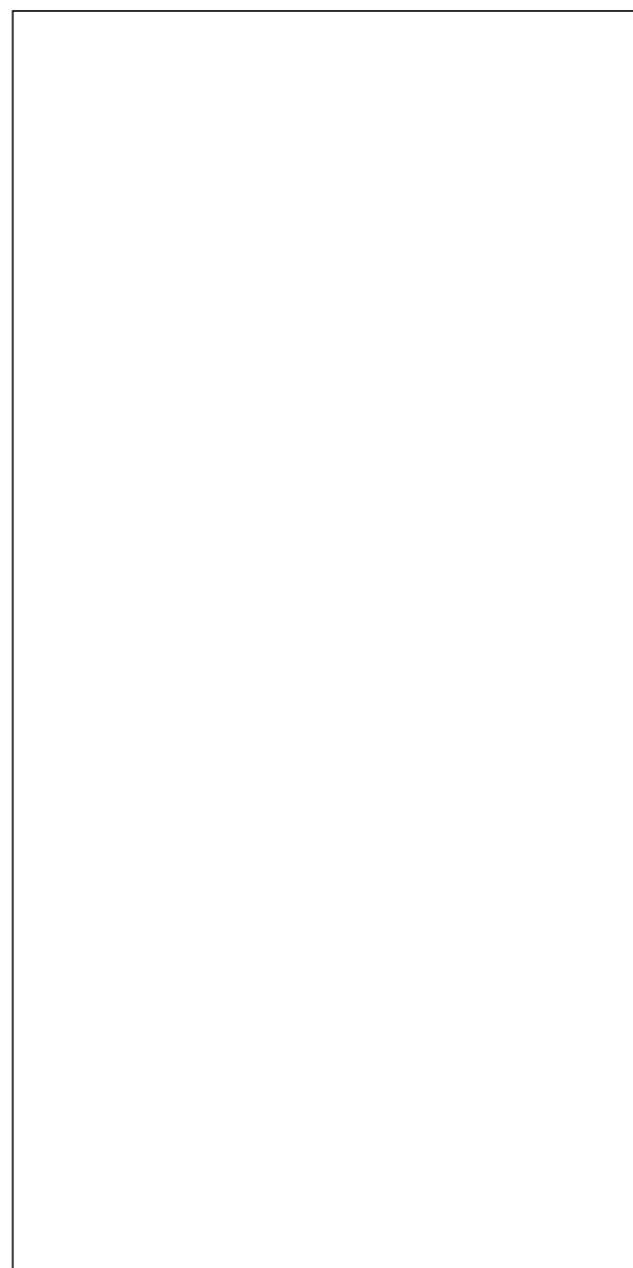

Not rectified porcelain slabs

162 x 324 cm

⚡ 12, 20 mm

159 x 324 cm

⚡ 20 mm

Rectified monocaliber porcelain slabs

160 x 320 cm

⚡ 6 mm

[BACK TO INDEX](#)

Natura technologies

The look of natural marble.

The vein pattern is reproduced through the full thickness of the slab.



The texture of natural stone.

The aesthetics of natural stone across both the surface and body of the slab.



Our finishes

The technical data sheets can be viewed and displayed on www.atlasplan.com

Polished



Silk



[BACK TO INDEX](#)

Leathered



Hammered



The shades of finishes reproduced here may not correspond perfectly with actual shades, due to limitations relating to the printing on paper.

Matte



New colors

2025

[BACK TO INDEX](#)

NEW COLOR

Ice Crystal



SIZE	THICKNESS	FINISH	CODE
not rectified			
162 x 324 cm 63 3/4" x 127 1/2"	± 12 mm	Polished Silk	AXXK AXXI
> BOOKMATCH	± 12 mm	Polished Silk	AXXL AXXJ

Also available in other sizes in the Atlas Concorde range.

NEW COLOR

Ice Crystal



SIZE	THICKNESS	FINISH	CODE
rectified monocaliber			
160 x 320 cm 63" x 126" > ENDLESS	± 6 mm	Polished Silk	AXXG AXXH
> KIT ENDLESS	± 6 mm	Polished Silk	AXYJ AXYK

Also available in other sizes in the Atlas Concorde range.



patterns

ENDLESS



[BACK TO INDEX](#)

NEW COLOR

Sky Stone



SIZE	THICKNESS	FINISH	CODE
not rectified			
162 x 324 cm 63 3/4" x 127 1/2"	± 12 mm	Silk	AXXM
> BOOKMATCH	± 12 mm	Silk	AXXN

Also available in other sizes in the Atlas Concorde range.

[BACK TO INDEX](#)

NEW COLOR

Taj Mahal



SIZE	THICKNESS	FINISH	CODE
not rectified			
162 x 324 cm 63 3/4" x 127 1/2"	± 12 mm	Polished Silk	AXXS AXXQ
> BOOKMATCH	± 12 mm	Polished Silk	AXXT AXXR
159 x 324 cm 62 3/4" x 127 1/2"	± 20 mm	Polished	AXXU

Also available in other sizes in the Atlas Concorde range.

[BACK TO INDEX](#)

NEW COLOR

Taj Mahal



SIZE	THICKNESS	FINISH	CODE
rectified monocaliber			
160 x 320 cm 63" x 126" > ENDLESS	± 6 mm	Polished Silk	AXXO AXXP
> KIT ENDLESS	± 6 mm	Polished Silk	AXYL AXYM

Also available in other sizes in the Atlas Concorde range.

patterns

ENDLESS

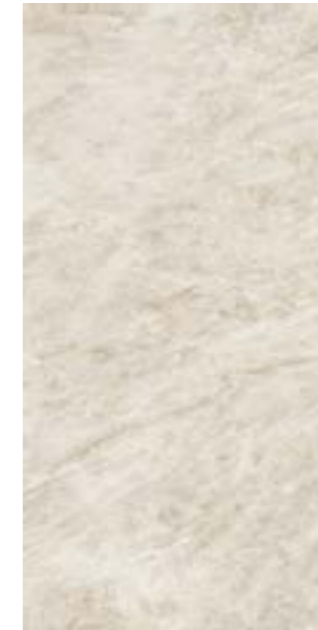
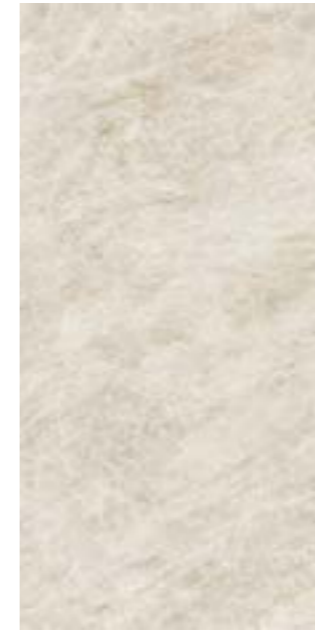
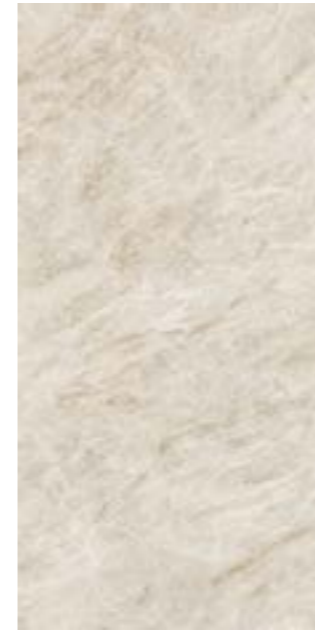

NEW COLOR

Baobab



SIZE	THICKNESS	FINISH	CODE
not rectified			
162 x 324 cm 63 3/4" x 127 1/2"	± 12 mm	Polished	AXXW
> BOOKMATCH	± 12 mm	Polished	AXX1

Also available in other sizes in the Atlas Concorde range.

NEW COLOR

Baobab



SIZE	THICKNESS	FINISH	CODE
rectified monocaliber			
160 x 320 cm 63" x 126" > ENDLESS	± 6 mm	Polished	AXXV
> KIT ENDLESS	± 6 mm	Polished	AXYN

Also available in other sizes in the Atlas Concorde range.

patterns

ENDLESS

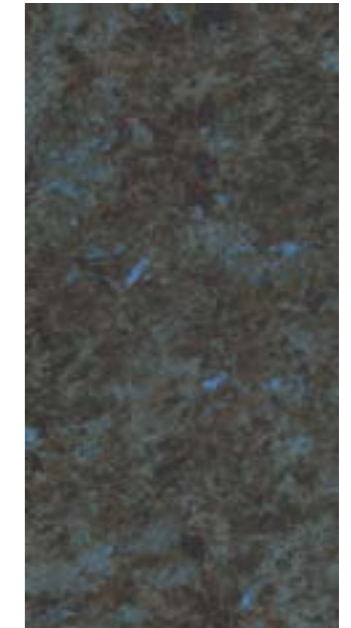
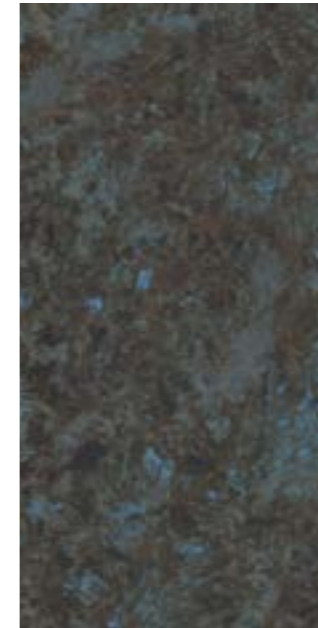

[BACK TO INDEX](#)

NEW COLOR

Black Tempest



SIZE	THICKNESS	FINISH	CODE
not rectified			
162 x 324 cm 63 3/4" x 127 1/2"	± 12 mm	Silk	AXXX
> BOOKMATCH	± 12 mm	Silk	AXXY

Also available in other sizes in the Atlas Concorde range.



NEW COLOR

Boost Icor Bone



SIZE	THICKNESS	FINISH	CODE
not rectified			
162 x 324 cm 63 3/4" x 127 1/2"	± 12 mm	Hammered	AX6L

Also available in other sizes in the Atlas Concorde range.

[BACK TO INDEX](#)

NEW COLOR

Boost Icor Bone



SIZE	THICKNESS	FINISH	CODE
rectified monocaliber			
160 x 320 cm 63" x 126"	± 6 mm	Hammered	AX6K

Also available in other sizes in the Atlas Concorde range.

patterns



[BACK TO INDEX](#)



NEW COLOR

Boost Icor Dune



SIZE	THICKNESS	FINISH	CODE
not rectified			
162 x 324 cm 63 3/4" x 127 1/2"	± 12 mm	Hammered	AX6N

Also available in other sizes in the Atlas Concorde range.

[BACK TO INDEX](#)

NEW COLOR

Boost Icor Dune



SIZE	THICKNESS	FINISH	CODE
rectified monocaliber			
160 x 320 cm 63" x 126"	± 6 mm	Hammered	AX6M

Also available in other sizes in the Atlas Concorde range.

patterns



[BACK TO INDEX](#)

NEW COLOR

Boost Natural Kaolin



SIZE	THICKNESS	FINISH	CODE
rectified monocaliber			
160 x 320 cm 63" x 126"	± 6 mm	Hammered	ALR0

Also available in other sizes in the Atlas Concorde range.

patterns



[BACK TO INDEX](#)

Color range

Appennino

atlasPLAN x MODULNOVA



SIZE	THICKNESS	FINISH	CODE
not rectified			
162 x 324 cm 63 3/4" x 127 1/2"	± 12 mm	Silk	AX0N
> BOOKMATCH	± 12 mm	Silk	AX0O
rectified monocaliber			
160 x 320 cm 63" x 126"	± 6 mm	Silk	ARTK
> BOOKMATCH	± 6 mm	Silk	ARTM



Silver Root

atlasPLAN x MODULNOVA



SIZE	THICKNESS	FINISH	CODE
not rectified			
162 x 324 cm 63 3/4" x 127 1/2"	± 12 mm	Silk	AX0R
> BOOKMATCH	± 12 mm	Silk	AX0S
rectified monocaliber			
160 x 320 cm 63" x 126"	± 6 mm	Silk	ARTN
> BOOKMATCH	± 6 mm	Silk	ARTO

Calacatta Gold



SIZE	THICKNESS	FINISH	CODE
not rectified			
162 x 324 cm 63 3/4" x 127 1/2"	± 12 mm	Polished Silk	AKFA AKE8
> BOOKMATCH	± 12 mm	Polished Silk	AKFB AKE9
159 x 324 cm 62 3/4" x 127 1/2"	± 20 mm	Polished	AKFC
> NATURA VEIN TECH			
rectified monocaliber			
160 x 320 cm 63" x 126"	± 6 mm	Polished	AKE6
> BOOKMATCH	± 6 mm	Polished	AKE7

For reasons related to the production process, the graphic of 20mm thick Natura Vein Tech products may not perfectly match the one illustrated here.

Calacatta Meraviglia



SIZE	THICKNESS	FINISH	CODE
not rectified			
162 x 324 cm 63 3/4" x 127 1/2"	± 12 mm	Polished Silk	AJHH AJHB
> BOOKMATCH	± 12 mm	Polished Silk	AJHI AJHC

Also available in other sizes in the Atlas Concorde range.

Calacatta Meraviglia



SIZE	THICKNESS	FINISH	CODE
rectified monocaliber			
160 x 320 cm 63" x 126"	± 6 mm	Polished	AJJ9
> BOOKMATCH	± 6 mm	Polished	AJKA
> ENDLESS	± 6 mm	Polished Matte	AJG9 AJSZ
> KIT ENDLESS	± 6 mm	Polished Matte	AKFI AKFJ

Also available in other sizes in the Atlas Concorde range.



patterns

BOOKMATCH

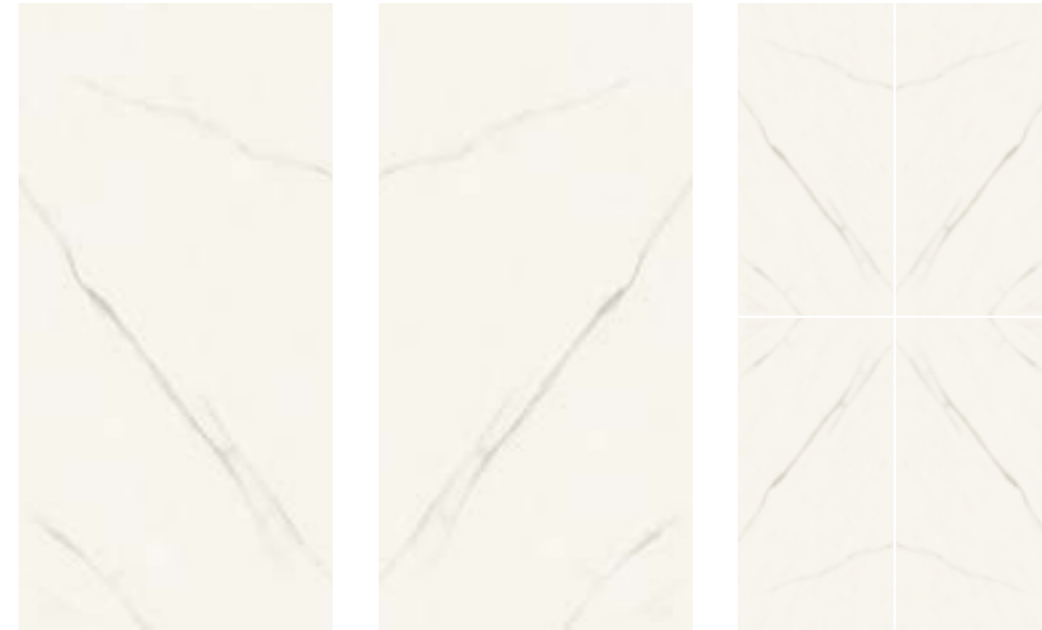

ENDLESS

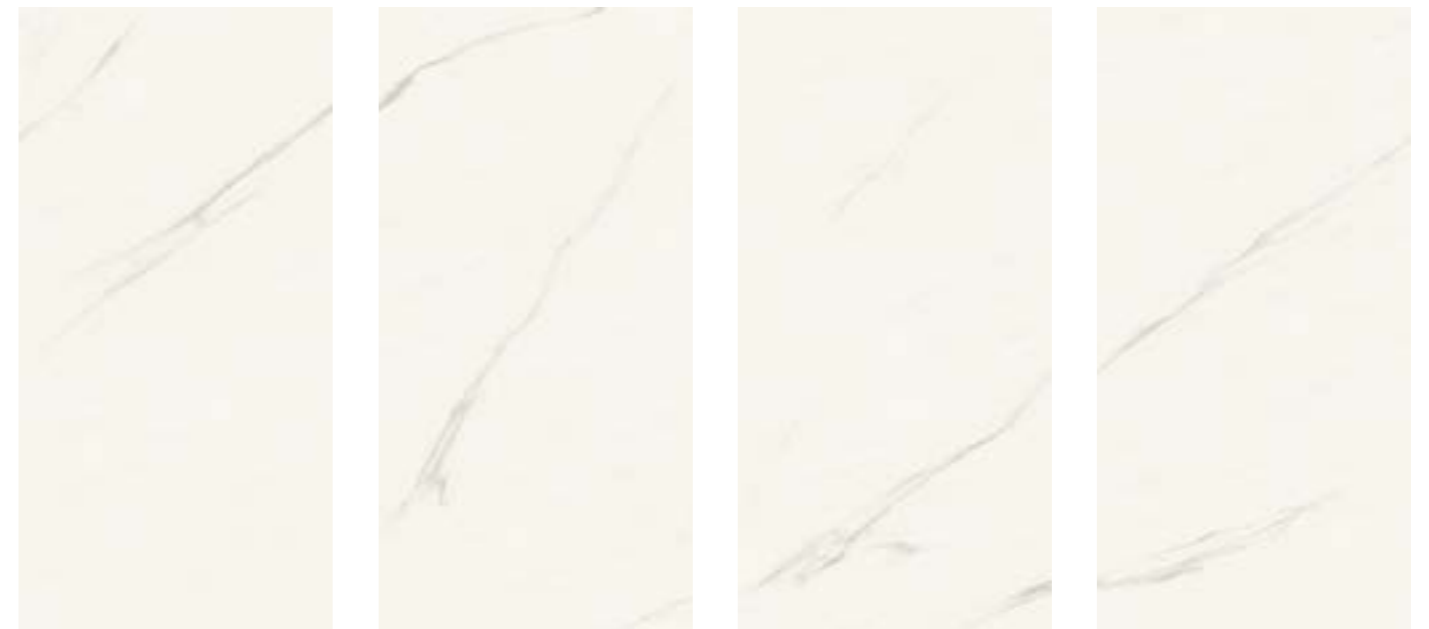

[BACK TO INDEX](#)

Calacatta Bernini



SIZE	THICKNESS	FINISH	CODE
not rectified			
162 x 324 cm 63 3/4" x 127 1/2"	± 12 mm	Polished Silk	AF5E AF5B
> BOOKMATCH	± 12 mm	Polished Silk	AF5K AF5C
159 x 324 cm 62 3/4" x 127 1/2"	± 20 mm	Polished Matte	AIRK AIRL
> NATURA VEIN TECH			
rectified monocaliber			
160 x 320 cm 63" x 126"	± 6 mm	Polished	AJRT
> BOOKMATCH	± 6 mm	Polished	AJRU

For reasons related to the production process, the graphic of 20mm thick Natura Vein Tech products may not perfectly match the one illustrated here.

Also available in other sizes in the Atlas Concorde range.



Calacatta Apuano



SIZE	THICKNESS	FINISH	CODE
not rectified			
162 x 324 cm 63 3/4" x 127 1/2"	± 12 mm	Polished Silk	AGRP AGRJ
> BOOKMATCH	± 12 mm	Polished Silk	AGRQ AGRL

Also available in other sizes in the Atlas Concorde range.

Calacatta Apuano



SIZE	THICKNESS	FINISH	CODE
rectified monocaliber			
160 x 320 cm 63" x 126" > ENDLESS	± 6 mm	Polished	AJRR
> KIT ENDLESS	± 6 mm	Polished	AKFN

Also available in other sizes in the Atlas Concorde range.



patterns

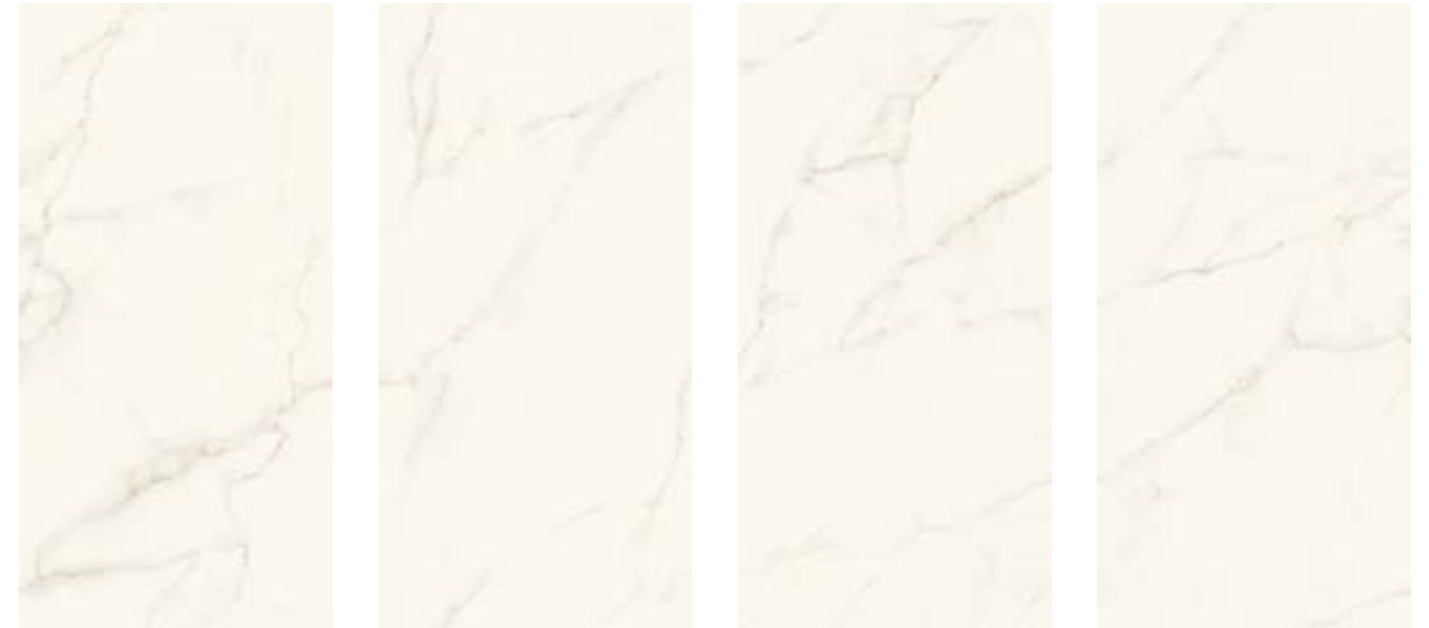

Calacatta Extra



SIZE	THICKNESS	FINISH	CODE
not rectified			
162 x 324 cm 63 3/4" x 127 1/2"	± 12 mm	Polished Silk	AAVD AA2T
> BOOKMATCH	± 12 mm	Polished Silk	AA2X AMJV
159 x 324 cm 62 3/4" x 127 1/2"	± 20 mm	Polished Matte	AIRN AIRQ
> BOOKMATCH	± 20 mm	Polished Matte	AIRP AIRR

Also available in other sizes in the Atlas Concorde range.



Calacatta Extra



SIZE	THICKNESS	FINISH	CODE
not rectified			
159 x 324 cm 62 3/4" x 127 1/2"	± 20 mm	Polished Matte	AIRM AILQ
> NATURA VEIN TECH			

For reasons related to the production process, the graphic of 20mm thick Natura Vein Tech products may not perfectly match the one illustrated here.

Also available in other sizes in the Atlas Concorde range.



[BACK TO INDEX](#)

Calacatta Extra



SIZE	THICKNESS	FINISH	CODE
rectified monocaliber			
160 x 320 cm 63" x 126"	± 6 mm	Polished Silk	AJKS AJKY
> BOOKMATCH	± 6 mm	Polished Silk	AJKT AJKZ



patterns

BOOKMATCH

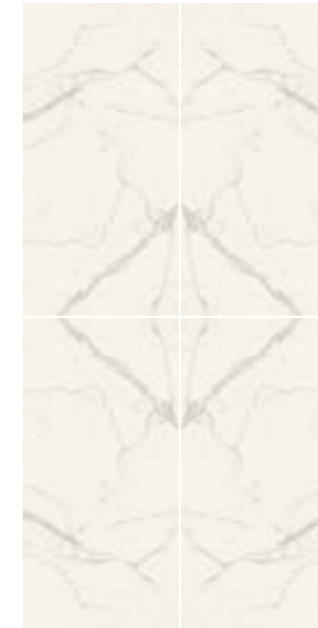
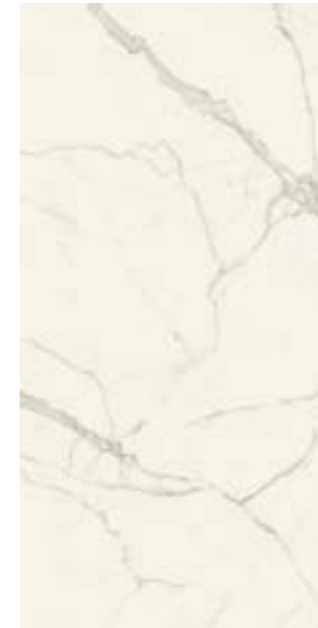
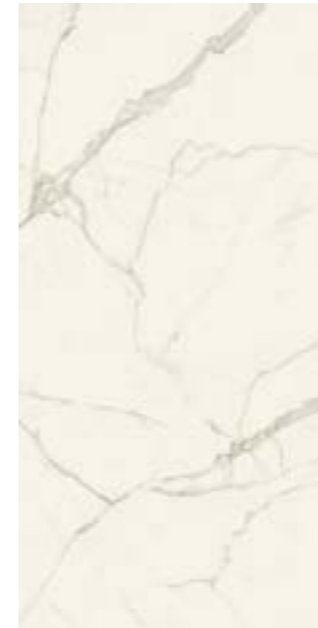

Also available in other sizes in the Atlas Concorde range.

[BACK TO INDEX](#)

Calacatta Antique



SIZE	THICKNESS	FINISH	CODE
not rectified			
162 x 324 cm 63 3/4" x 127 1/2"	± 12 mm	Polished	A0XZ
> BOOKMATCH	± 12 mm	Polished	A8T7



Calacatta Imperiale



SIZE	THICKNESS	FINISH	CODE
not rectified			
162 x 324 cm 63 3/4" x 127 1/2"	± 12 mm	Polished Silk	A0XI A0XV
> BOOKMATCH	± 12 mm	Polished Silk	A0XT A0XX
rectified monocaliber			
160 x 320 cm 63" x 126"	± 6 mm	Silk	AJK0
> BOOKMATCH	± 6 mm	Silk	AJK1

Also available in other sizes in the Atlas Concorde range.



Calacatta Imperiale



SIZE	THICKNESS	FINISH	CODE
not rectified			
159 x 324 cm 62 3/4" x 127 1/2"	± 20 mm	Polished Matte	AIRS AILP

For reasons related to the production process, the graphic of 20mm thick Natura Vein Tech products may not perfectly match the one illustrated here.

Also available in other sizes in the Atlas Concorde range.

Calacatta Delicato



SIZE	THICKNESS	FINISH	CODE
not rectified			
162 x 324 cm 63 3/4" x 127 1/2"	± 12 mm	Silk	A4T3

Also available in other sizes in the Atlas Concorde range.

Calacatta Prestigio



SIZE	THICKNESS	FINISH	CODE
not rectified			
162 x 324 cm 63 3/4" x 127 1/2"	± 12 mm	Silk	A4T0
> BOOKMATCH	± 12 mm	Silk	A4T1

Also available in other sizes in the Atlas Concorde range.

Calacatta Prestigio



SIZE	THICKNESS	FINISH	CODE
rectified monocaliber			
160 x 320 cm 63" x 126" ENDLESS	± 6 mm	Polished	A4RR
> KIT ENDLESS	± 6 mm	Polished	AKFL



patterns



Also available in other sizes in the Atlas Concorde range.

[BACK TO INDEX](#)

Crystal White



SIZE	THICKNESS	FINISH	CODE
not rectified			
162 x 324 cm 63 3/4" x 127 1/2"	± 12 mm	Polished Silk	A9C2 A9C4
> BOOKMATCH	± 12 mm	Polished Silk	AF2W AF2X
159 x 324 cm 62 3/4" x 127 1/2"	± 20 mm	Polished	AIRJ
> BOOKMATCH	± 20 mm	Polished	AIRH
rectified monocaliber			
160 x 320 cm 63" x 126"	± 6 mm	Polished	AJKU
> BOOKMATCH	± 6 mm	Polished	AJKV

Also available in other sizes in the Atlas Concorde range.

Onyx White



SIZE	THICKNESS	FINISH	CODE
not rectified			
162 x 324 cm 63 3/4" x 127 1/2"	± 12 mm	Polished Silk	AJHJ AJHD
> BOOKMATCH	± 12 mm	Polished Silk	AJHK AJHE
rectified monocaliber			
160 x 320 cm 63" x 126"	± 6 mm	Polished	AJHA
> BOOKMATCH	± 6 mm	Polished	AJKB

Also available in other sizes in the Atlas Concorde range.

[BACK TO INDEX](#)

White Cloud



SIZE	THICKNESS	FINISH	CODE
not rectified			
162 x 324 cm 63 3/4" x 127 1/2"	± 12 mm	Silk	A4UO

Bianco Dolomite



SIZE	THICKNESS	FINISH	CODE
not rectified			
162 x 324 cm 63 3/4" x 127 1/2"	± 12 mm	Polished	AAVG
159 x 324 cm 62 3/4" x 127 1/2"	± 20 mm	Polished	AILN

Also available in other sizes in the Atlas Concorde range.

[BACK TO INDEX](#)

Statuario Supremo



SIZE	THICKNESS	FINISH	CODE
not rectified			
162 x 324 cm 63 3/4" x 127 1/2"	± 12 mm	Polished Silk	AF6A A4TX
> BOOKMATCH	± 12 mm	Polished Silk	AF6B A4TY

Also available in other sizes in the Atlas Concorde range.



Statuario Supremo

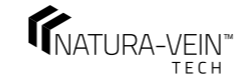

SIZE	THICKNESS	FINISH	CODE
not rectified			
159 x 324 cm 62 3/4" x 127 1/2"	± 20 mm	Polished Matte	AILO AIRT
> NATURA VEIN TECH			

For reasons related to the production process, the graphic of 20mm thick Natura Vein Tech products may not perfectly match the one illustrated here.

[BACK TO INDEX](#)



Travertino White



SIZE	THICKNESS	FINISH	CODE
not rectified			
162 x 324 cm 63 3/4" x 127 1/2"	± 12 mm	Hammered	ALYX
rectified monocaliber			
160 x 320 cm 63" x 126"	± 6 mm	Hammered	ALYW

Also available in other sizes in the Atlas Concorde range.

[BACK TO INDEX](#)

Travertino Pearl



SIZE	THICKNESS	FINISH	CODE
not rectified			
162 x 324 cm 63 3/4" x 127 1/2"	± 12 mm	Hammered	AF4Z
rectified monocaliber			
160 x 320 cm 63" x 126"	± 6 mm	Hammered	ALYV

Also available in other sizes in the Atlas Concorde range.

Travertino Sand



SIZE	THICKNESS	FINISH	CODE
not rectified			
162 x 324 cm 63 3/4" x 127 1/2"	± 12 mm	Hammered	A647
rectified monocaliber			
160 x 320 cm 63" x 126"	± 6 mm	Hammered	AJKQ

Also available in other sizes in the Atlas Concorde range.



Cream Prestige



SIZE	THICKNESS	FINISH	CODE
not rectified			
162 x 324 cm 63 3/4" x 127 1/2"	± 12 mm	Silk	AAV6

Also available in other sizes in the Atlas Concorde range.

[BACK TO INDEX](#)

Desert Soul



SIZE	THICKNESS	FINISH	CODE
not rectified			
162 x 324 cm 63 3/4" x 127 1/2"	± 12 mm	Polished Silk	A9CW A9CZ
	± 20 mm	Polished	A9C7
> BOOKMATCH	± 12 mm	Polished Silk	A9CX A9C0
	± 20 mm	Polished	A9C8
rectified monocaliber			
160 x 320 cm 63" x 126"	± 6 mm	Polished	AJKG
> BOOKMATCH	± 6 mm	Polished	AJKH

Also available in other sizes in the Atlas Concorde range.



Exotic Wave



SIZE	THICKNESS	FINISH	CODE
not rectified			
162 x 324 cm 63 3/4" x 127 1/2"	± 12 mm	Polished	A9CT
> BOOKMATCH	± 12 mm	Polished	A9CU
rectified monocaliber			
160 x 320 cm 63" x 126"	± 6 mm	Polished	AJRN
> BOOKMATCH	± 6 mm	Polished	AJRO



[BACK TO INDEX](#)

Exotic Green



SIZE	THICKNESS	FINISH	CODE
not rectified			
162 x 324 cm 63 3/4" x 127 1/2"	± 12 mm	Polished	A9CN
> BOOKMATCH	± 12 mm	Polished	A9CO
rectified monocaliber			
160 x 320 cm 63" x 126"	± 6 mm	Polished	AJRP
> BOOKMATCH	± 6 mm	Polished	AJRQ

Also available in other sizes in the Atlas Concorde range.

[BACK TO INDEX](#)

Fior Di Bosco



SIZE	THICKNESS	FINISH	CODE
not rectified			
162 x 324 cm 63 3/4" x 127 1/2"	± 12 mm	Polished Silk	AIRZ AIBE
> BOOKMATCH	± 12 mm	Polished Silk	AIR3 AIBF
rectified monocaliber			
160 x 320 cm 63" x 126"	± 6 mm	Polished Silk	AJRV AYB4
> BOOKMATCH	± 6 mm	Polished Silk	AJRW AYB5

Also available in other sizes in the Atlas Concorde range.

Light Grey Stone



SIZE	THICKNESS	FINISH	CODE
not rectified			
162 x 324 cm 63 3/4" x 127 1/2"	± 12 mm	Silk	AMJ9
rectified monocaliber			
160 x 320 cm 63" x 126"	± 6 mm	Silk	ABGZ

Grey Stone



SIZE	THICKNESS	FINISH	CODE
not rectified			
162 x 324 cm 63 3/4" x 127 1/2"	± 12 mm	Silk	AAWA
	± 20 mm	Matte	AHH2
rectified monocaliber			
160 x 320 cm 63" x 126"	± 6 mm	Silk	AJKX

Also available in other sizes in the Atlas Concorde range.

[BACK TO INDEX](#)

Precious Brown



SIZE	THICKNESS	FINISH	CODE
not rectified			
162 x 324 cm 63 3/4" x 127 1/2"	± 12 mm	Silk	AJHF
> BOOKMATCH	± 12 mm	Silk	AJHG
rectified monocaliber			
160 x 320 cm 63" x 126"	± 6 mm	Silk	AKGB
> BOOKMATCH	± 6 mm	Silk	AKGC

Also available in other sizes in the Atlas Concorde range.

Nero Marquina



SIZE	THICKNESS	FINISH	CODE
not rectified			
162 x 324 cm 63 3/4" x 127 1/2"	± 12 mm	Polished Silk	ANWA ANVK
	± 20 mm	Matte	AHH5
> BOOKMATCH	± 12 mm	Polished Silk	A6T5 A6T4
rectified monocaliber			
160 x 320 cm 63" x 126"	± 6 mm	Polished Silk	AJKW AJK2

Also available in other sizes in the Atlas Concorde range.

[BACK TO INDEX](#)

Black Atlantis



SIZE	THICKNESS	FINISH	CODE
not rectified			
162 x 324 cm 63 3/4" x 127 1/2"	± 12 mm	Polished Silk	A9CK A8XV
> BOOKMATCH	± 12 mm	Polished Silk	A9CL A8XW

Also available in other sizes in the Atlas Concorde range.

[BACK TO INDEX](#)

Boost Stone Ivory



SIZE	THICKNESS	FINISH	CODE
not rectified			
162 x 324 cm 63 3/4" x 127 1/2"	± 12 mm	Hammered	A648
rectified monocaliber			
160 x 320 cm 63" x 126"	± 6 mm	Hammered	AJRX

Also available in other sizes in the Atlas Concorde range.

Boost Mineral Grey



SIZE	THICKNESS	FINISH	CODE
not rectified			
162 x 324 cm 63 3/4" x 127 1/2"	± 12 mm	Hammered	AHV6
rectified monocaliber			
160 x 320 cm 63" x 126"	± 6 mm	Hammered	AKGA

Also available in other sizes in the Atlas Concorde range.

Kone Mix



SIZE	THICKNESS	FINISH	CODE
not rectified			
162 x 324 cm 63 3/4" x 127 1/2"	± 12 mm	Hammered	AMSX
rectified monocaliber			
160 x 320 cm 63" x 126"	± 6 mm	Hammered	AJKP

Also available in other sizes in the Atlas Concorde range.

Basaltina Volcano



SIZE	THICKNESS	FINISH	CODE
not rectified			
162 x 324 cm 63 3/4" x 127 1/2"	± 12 mm	Hammered	ANVI
	± 20 mm	Hammered	A2XS
rectified monocaliber			
160 x 320 cm 63" x 126"	± 6 mm	Hammered	AJKO



Negresco



SIZE	THICKNESS	FINISH	CODE
not rectified			
162 x 324 cm 63 3/4" x 127 1/2"	± 12 mm	Silk	ARCR

Soapstone Dark



SIZE	THICKNESS	FINISH	CODE
not rectified			
162 x 324 cm 63 3/4" x 127 1/2"	± 12 mm	Hammered	A4UN
	± 20 mm	Hammered	A5I3

Noce Canaletto

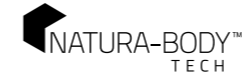

SIZE	THICKNESS	FINISH	CODE
not rectified			
162 x 324 cm 63 3/4" x 127 1/2"	± 12 mm	Matte	AKFE
> NATURA BODY TECH			
rectified monocaliber			
160 x 320 cm 63" x 126"	± 6 mm	Matte	AKFD



Boost White



SIZE	THICKNESS	FINISH	CODE
not rectified			
162 x 324 cm 63 3/4" x 127 1/2"	± 12 mm	Hammered	ANVX

Also available in other sizes in the Atlas Concorde range.

[BACK TO INDEX](#)

Boost White



SIZE	THICKNESS	FINISH	CODE
rectified monocaliber			
160 x 320 cm 63" x 126"	± 6 mm	Hammered	AO5Z

Also available in other sizes in the Atlas Concorde range.

patterns



[BACK TO INDEX](#)



NEW COLOR

Boost Balance Ash



SIZE	THICKNESS	FINISH	CODE
not rectified			
162 x 324 cm 63 3/4" x 127 1/2"	± 12 mm	Matte	AJKC

Also available in other sizes in the Atlas Concorde range.

[BACK TO INDEX](#)

NEW COLOR

Boost Balance Ash



SIZE	THICKNESS	FINISH	CODE
rectified monocaliber			
160 x 320 cm 63" x 126"	± 6 mm	Matte	AJG4

Also available in other sizes in the Atlas Concorde range.

patterns



[BACK TO INDEX](#)

Boost Natural Pro Sand



SIZE	THICKNESS	FINISH	CODE
not rectified			
162 x 324 cm 63 3/4" x 127 1/2"	± 12 mm	Hammered	ARCQ

Also available in other sizes in the Atlas Concorde range.

Boost Natural E cru



SIZE	THICKNESS	FINISH	CODE
not rectified			
162 x 324 cm 63 3/4" x 127 1/2"	± 12 mm	Hammered	A649

Also available in other sizes in the Atlas Concorde range.



Boost Grey



SIZE	THICKNESS	FINISH	CODE
not rectified			
162 x 324 cm 63 3/4" x 127 1/2"	± 12 mm	Hammered	A65C

Also available in other sizes in the Atlas Concorde range.

[BACK TO INDEX](#)

Boost Grey



SIZE	THICKNESS	FINISH	CODE
rectified monocaliber			
160 x 320 cm 63" x 126"	± 6 mm	Hammered	A681

Also available in other sizes in the Atlas Concorde range.

patterns



[BACK TO INDEX](#)



Boost Smoke



SIZE	THICKNESS	FINISH	CODE
not rectified			
162 x 324 cm 63 3/4" x 127 1/2"	± 12 mm	Hammered	ANV0

Also available in other sizes in the Atlas Concorde range.

[BACK TO INDEX](#)

Boost Smoke



SIZE	THICKNESS	FINISH	CODE
rectified monocaliber			
160 x 320 cm 63" x 126"	± 6 mm	Hammered	AO50

Also available in other sizes in the Atlas Concorde range.

patterns





Boost Tarmac



SIZE	THICKNESS	FINISH	CODE
not rectified			
162 x 324 cm 63 3/4" x 127 1/2"	± 12 mm	Hammered	A65D

Also available in other sizes in the Atlas Concorde range.

[BACK TO INDEX](#)

Boost Tarmac



SIZE	THICKNESS	FINISH	CODE
rectified monocaliber			
160 x 320 cm 63" x 126"	± 6 mm	Hammered	A68J

Also available in other sizes in the Atlas Concorde range.

patterns



[BACK TO INDEX](#)

Absolute White



SIZE	THICKNESS	FINISH	CODE
not rectified			
162 x 324 cm 63 3/4" x 127 1/2"	± 12 mm	Polished Matte	A4T4 AG1N
159 x 324 cm 62 3/4" x 127 1/2"	± 20 mm	Matte	AIRU
rectified monocaliber			
160 x 320 cm 63" x 126"	± 6 mm	Matte	AJKR

Absolute Black



SIZE	THICKNESS	FINISH	CODE
not rectified			
162 x 324 cm 63 3/4" x 127 1/2"	± 12 mm	Matte	AG1G

Black Lava



SIZE	THICKNESS	FINISH	CODE
not rectified			
162 x 324 cm 63 3/4" x 127 1/2"	± 12 mm	Leathered	AF5A
	± 20 mm	Leathered	AF5M



Blaze Iron



SIZE	THICKNESS	FINISH	CODE
not rectified			
162 x 324 cm 63 3/4" x 127 1/2"	± 12 mm	Matte	A3ND

Also available in other sizes in the Atlas Concorde range.

Technical specifications



162x324 cm - 63³/₄"x127¹/₂"
NOT RECTIFIED SLAB



159x324 cm - 62³/₄"x127¹/₂"
NOT RECTIFIED SLAB



160x320 cm - 63"x126"
RECTIFIED MONOCALIBER

Complies with EN 14411 (ISO 13006) Appendix G Group Bla

- (*) The permissible deviation, in % or mm, of the average size for each tile (2 or 4 sides) from work size (WS).
- (**) The permissible deviation, in % or mm, of the average thickness for each tile from the work size thickness (WS).
- (***) The maximum permissible deviation from straightness, in % or mm, related to the corresponding work sizes (WS).
- (****) The maximum permissible deviation from rectangularity, in % or mm, related to the corresponding work sizes (WS).
- c.c. The maximum permissible deviation from centre curvature, in % or mm, related to diagonal calculated from the work sizes (WS).
- e.c. The maximum permissible deviation from edge curvature, in % or mm, related to the corresponding work sizes (WS).
- w. The maximum permissible deviation from warpage, in % or mm, related to diagonal calculated from the work sizes (WS).
- (1) Determination of slip resistance of pedestrian surfaces; it does not cover sports surfaces and road surfaces for vehicles (skid resistance).
- (2) Anti-slip performance is guaranteed at the time of delivery of the product.
- (3) However, tiles with a DCOF of 0.42 or greater are not necessarily suitable for all projects. The specifier shall determine tiles appropriate for specific project conditions, considering by way of example, but not in limitation, type of use, traffic, expected contaminants, expected maintenance, expected wear, and manufacturers' guidelines and recommendations."
- (4) For further details, please refer to outdoor design general catalogue.
- (5) Only for products with 20 mm thickness.

Technical features

		Requirements for nominal size N		162x324 cm - 63 ³ / ₄ "x127 ¹ / ₂ " 159x324 cm - 62 ³ / ₄ "x127 ¹ / ₂ " Not Rectified			160x320 cm - 63"x127" Rectified			
		N ≥ 15 cm		Silk	Matte Hammered Leathered	Polished	Silk	Matte Hammered	Polished	
		(%)	(mm)							
Regularity characteristics	Length and width	ISO 10545-2	± 0,3 (*)	± 1 (*)	N.A.			Suitable for		
	Thickness		± 5 (**)	± 0,5 (**)	Suitable for Conforme			Suitable for		
	Straightness of sides		± 0,3 (***)	± 0,8 (***)	N.A.			Suitable for		
	Rectangularity (Measurement only on short edges when L/l ≥ 3)		± 0,3 (****)	± 1,5 (****)	N.A.			Suitable for		
	Surface flatness		c.c. ± 0,4 e.c. ± 0,4 w. ± 0,4	c.c. ± 1,8 e.c. ± 1,8 w. ± 1,8	Suitable for			Suitable for		
Structural characteristics	Water absorption	ISO 10545-3	E, ≤ 0,5% Individual max 0,6%		≤ 0,1 %			≤ 0,1 %		
		ASTM C373-18	Requirement ANSI A137.1 Water Absorption Max ≤ 0,5%		≤ 0,5 %			≤ 0,5 %		
Bulk mechanical characteristics	Breaking strength	ISO 10545-4	S ≥ 700 N for thickness < 7,5mm	S ≥ 1300 N for thickness ≥ 7,5mm	12 mm -> S ≥ 3500N 20 mm -> S ≥ 10000N			S ≥ 1000N		
	Modulus of rupture		R ≥ 35 N/mm ²		R ≥ 40 N/mm ²			R ≥ 40 N/mm ²		
	Impact resistance, as coefficient of restitution		ISO 10545-5	Declared value		≥ 0,55			≥ 0,55	
Surface mechanical characteristics	Resistance to deep abrasion of unglazed tiles (removed volume)	ISO 10545-6	≤ 175 mm ³		Suitable for			Suitable for		
	Coefficient of thermal linear expansion	ISO 10545-8	Declared value		≤ 7 MK ⁻¹			≤ 7 MK ⁻¹		
Thermal and hygrometric characteristics	Thermal shock resistance	ISO 10545-9	Pass according to EN ISO 10545-1		Resistant			Resistant		
	Moisture expansion (in mm/m)	ISO 10545-10	Declared value		≤ 0,01% (0,1mm/m)			≤ 0,01% (0,1mm/m)		
	Frost resistance	ISO 10545-12	Pass according to EN ISO 10545-1		Resistant Resiste			Resistant Resiste		
Physical properties	Bond strength/adhesion for improved cementitious adhesives	EN 1348	Declared value		≥ 1,0 N/mm ² (Class C2 - EN 12004)			≥ 1,0 N/mm ² (Class C2 - EN 12004)		
	Reaction to fire	-	A1 or Afl		A1 without fiberglass - A2 with fiberglass			A1 - A1fl		
Chemical characteristics	Resistance to household chemicals and swimming pool salts	ISO 10545-13	Minimum Class B (B for unglazed tiles)		A			A		
	Resistance to low concentrations of acids and alkalis		Declared Class		LA			LA		
	Resistance to high concentrations of acids and alkalis		Declared Class		HA HA -			HA HA -		
	Resistance to staining	ISO 10545-14	Declared Class		5			5		
Safety characteristics (1)(2)	Release of dangerous substances: Cadmium (in mg/dm ²) and Lead (in mg/dm ²)	ISO 10545-15	Declared value		≤ 0,01 mg/dm ² Cd ≤ 0,1 mg/dm ² Pb			≤ 0,01 mg/dm ² Cd ≤ 0,1 mg/dm ² Pb		
	Shod Ramp Test	DIN EN 16165 ANNEX B (EX DIN 51130)	Declared Class		-			-		
	Barefoot Ramp Test	DIN EN 16165 ANNEX A (EX DIN 51097)	Declared Class		-			-		
	Coefficient of friction (COF)	B.C.R.A. Rep. CEC/81	D.M. 236/89 dated 14/06/89 μ > 0,40 for leather sliding element on dry flooring μ > 0,40 for hard rubber sliding element on wet flooring		-			> 0,40 dry > 0,40 wet		
	Dynamic coefficient of friction (DCOF)	ANSI A 326,3	-		-			wet DCOF > 0,42 dry DCOF > 0,42		
	Resistance to scratching	UNI EN 15186:2012 met.B	-		CEN/TS 16209 Class A			CEN/TS 16209 Class A		
	Tendency to retain dirt	UNI 9300:2015	-		No visible change (5)			No visible change (5)		
	Surface resistance to cold liquids	UNI EN 12720:2013	-		CEN/TS 16209 Class A			CEN/TS 16209 Class A		
	Surface resistance to wet heat	UNI EN 12721:2013	-		CEN/TS 16209 Class A			CEN/TS 16209 Class A		
	Surface resistance to dry heat	UNI EN 12722:2013	-		CEN/TS 16209 Class A			CEN/TS 16209 Class A		
	Assessment of resistance to impact	ISO 4211-4:1988	-		Maximum drop height according to thickness			Maximum drop height according to thickness		

BACK TO INDEX

Packaging

Atlas Plan slabs can be shipped in wooden crates or on A-frames made of wood or galvanized steel, according to the customer's choice.

Crates

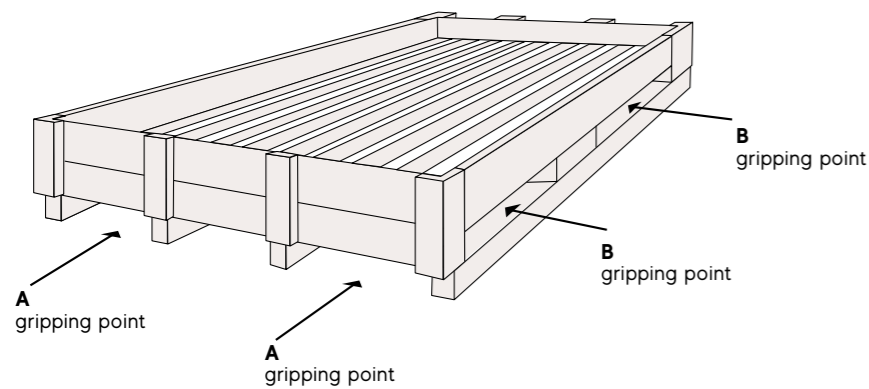

Crate storage
 The wooden crates can be stacked on top of each other. Up to 7 crates can be stacked. Up to 9 crates can be stacked providing they are placed on a concrete floor. However, it is not possible to place a load of different size than that of the crate itself on top. The crates can be stored outdoors for up to 6 months.

MATERIAL	CERTIFICATION	EXTERIOR DIMENSIONS [MM - INCHES]	WEIGHT [KG - LBS]	GRIPPING POINTS
Wood	Structural and phytosanitary features*	3442x1745x374 135"x69" x15"	140 - 308,6	4-way (A or B)

*Phytosanitary certification refers to International Standard ISPM-15.

Transport in crates

THICKNESS [MM - INCHES]	SLABS LOADABLE IN CRATE	SQUARE METRES LOADABLE IN CRATE [M ² - SQFT]	CRATE WEIGHT IN MAXIMUM LOAD CONDITIONS [KG - LBS]*
20 - 3/4"	4	21 - 226	1106 - 2438
12 - 1/2"	8	42 - 452	1300 - 2866
6 - 1/4"	14	73.5 - 150,7	1155 - 2546

*weight tolerance of slabs 5%

A foam corner protection is applied when the slabs are loaded into the crates. A polystyrene sheet is placed on the bottom of the crate. The loading of each crate is then completed by applying a heat-shrink cap.

A-frame

Wooden A-frame

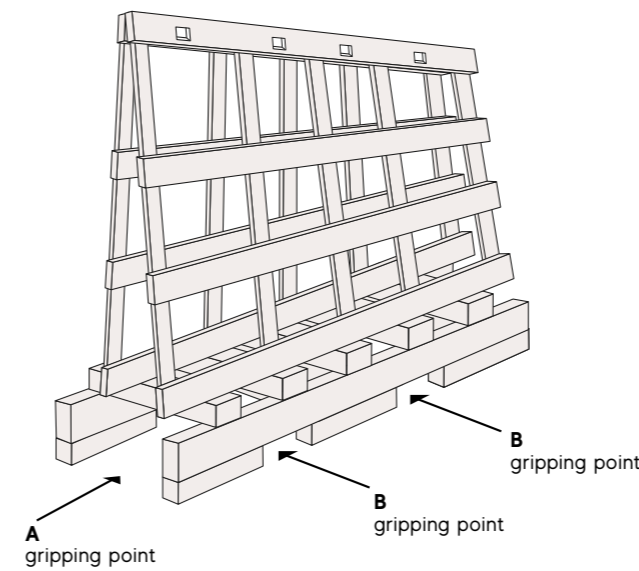

Steel A-frame

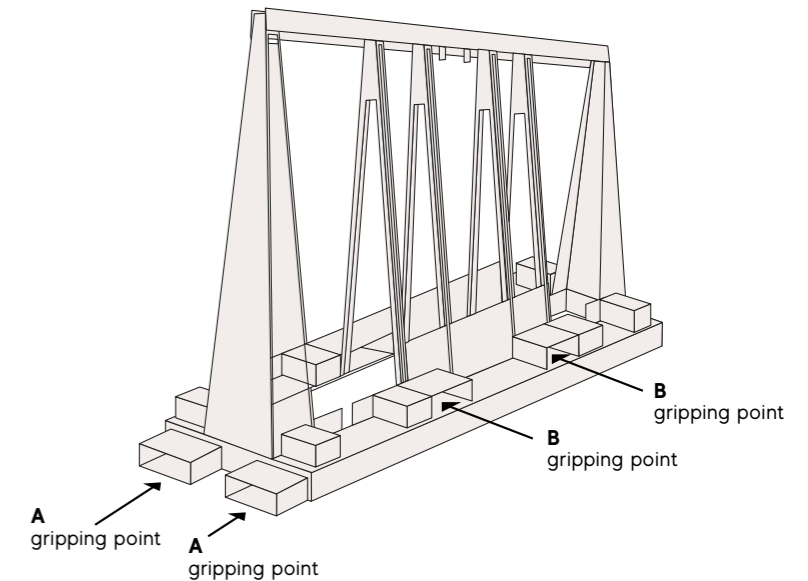

MATERIAL	CERTIFICATION	DIMENSIONS [MM - INCHES]	WEIGHT [KG - LBS]	GRIPPING POINTS
Wood	Structural and phytosanitary features*	3300x750x1953 130"x30" x77"	205 - 452	4-way (A or B)
Galvanised steel	Structural	3300x750x1950 130"x30" x77"	176 - 388	4-way (A or B)

*The structural certification refers to the following standards: UNI 91251, UNI EN 1995-1, UNI EN 12246, UNI EN 12248, UNI EN 636, UNI EN 12369-2; the phytosanitary certification refers to international standard ISPM-15.

A-frame storage
 A third A-frame can be inserted upside-down between two wooden A-frames placed side-by-side to optimise empty A-frame storage space. Up to 6 galvanized steel A-frames can be stacked.

Transport on A-frames

SLAB THICKNESS [MM - INCHES]	SLABS LOADABLE ON A-FRAMES	SQUARE METRES LOADABLE ON A-FRAME [M ² - SQFT]	A-FRAME WEIGHT IN MAXIMUM LOAD CONDITIONS [KG - LBS]*	
			WOODEN A-FRAME	STEEL A-FRAME
20 - 3/4"	12	63 - 678	3103 - 6841	3074 - 6777
12 - 1/2"	22	115,5 - 1243	3400 - 7496	3366 - 7421
6 - 1/4"	42	220 - 2368	3250 - 7165	3221 - 7101

*weight tolerance of slabs equal to 5%

Once loaded, the slabs are fixed to the packaging by applying four vertical straps. The packaging is then covered by a heat-shrinkable cap. Incomplete loads must be balanced between the two sides of the A-frame.

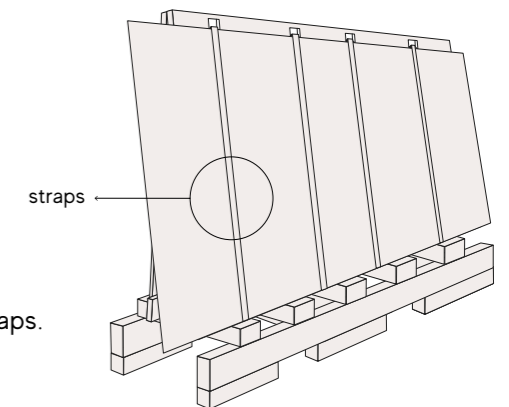

Bundles

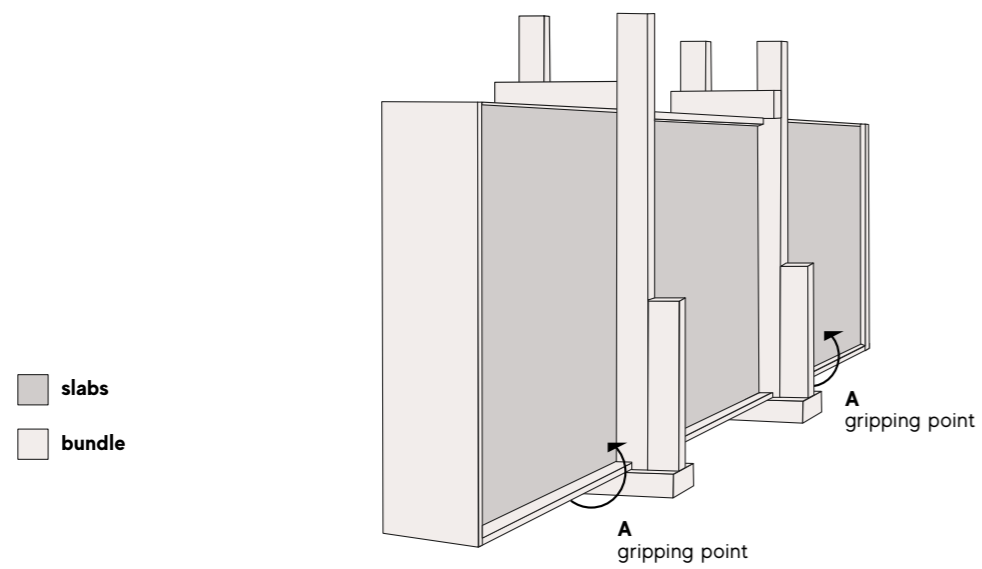

MATERIAL	CERTIFICATION	EXTERIOR DIMENSIONS [MM - INCHES]	WEIGHT [KG - LBS]	GRIPPING POINTS
Wood	Phyosanitary	3300x540x1800 130"x21"x71"	30-40 66-88	Base (A)

Bundles storage

Bundles can be stocked parallel on the ground. The bundles can be stored outdoors for up to 6 months. It is not recommended to store bundles outdoor for more than 6 months.

Transport on bundles

THICKNESS [MM - INCHES]	SLABS LOADABLE ON BUNDLES	SQUARE METRES LOADABLE ON BUNDLES [M ² - SQFT]	BUNDLES WEIGHT IN MAXIMUM LOAD CONDITIONS [KG - LBS]*
12 - 1/2"	18	94,5 - 1017,2	2650 - 5842
20 - 3/4"	12	63 - 678	2920 - 6437,5

*weight tolerance of slabs 5%

atlasPLAN

THE SIZE OF EMOTIONS